

Forte 85 Single 1620

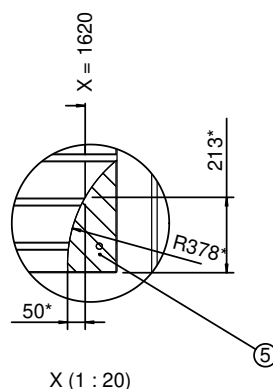
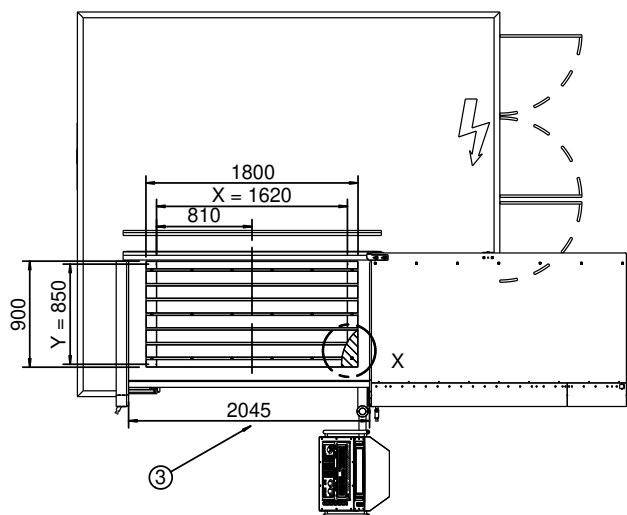
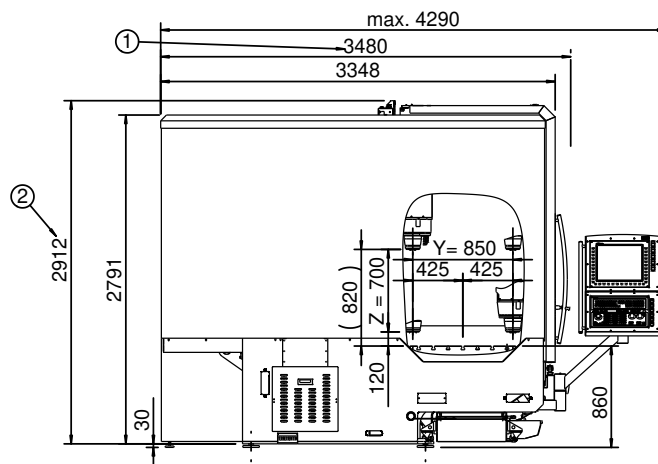
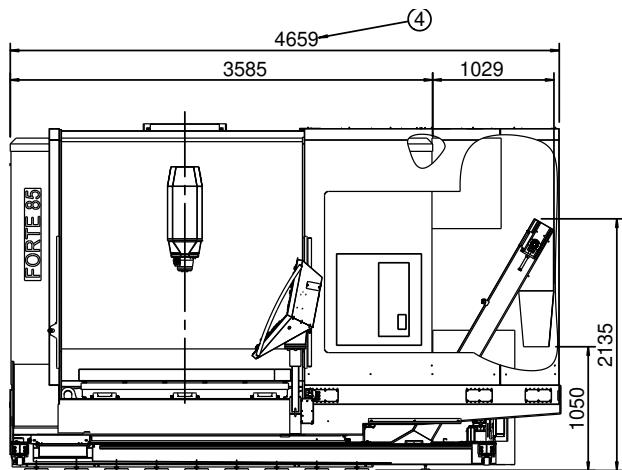

①	Liefer-/Transportbreite: 3480 mm	Delivery/transportation width: 3480 mm	Livraison/Transport largeur: 3480 mm	Altezza di spedizione/trasporto: 3480 mm	Levering / Transport breedte: 3480 mm	Транспортная ширина 3480 mm
②	Liefer-/Transporthöhe: 2912 mm	Delivery/transportation height: 2912 mm	Livraison/Transport taille: 2912 mm	Altezza di spedizione/trasporto: 2912 mm	Levering / Transport hoogte: 2912 mm	Транспортная высота 2912 mm
③	Bedienöffnung bei geöffneter Tür	Service opening	Ouverture de manoeuvre avec portes ouvertes	Apertura di manovra con porta aperta	Opening van de operatie met geopende deur	Проем при открытой дверце
④	Bei geöffneter Tür	With opened door	Avec des portes ouvertes	Con porte aperte	Met geopende deur	При открытой дверце
⑤	Werkzeugwechselfeld (*Werte bei max. Werkzeugabmessung): Diesen Bereich für den Werkzeug- wechsel freihalten.	Tool change area (*values at maximum tool size): Keep this area free for tool changes.	Zone de changement d'outil (*Les valeurs à maximale dimension de l'outil): Garder cette zone pour le changement d'outils.	Zone per cambio utensile (*valori in formato massimo utensile): Mantenere questa zona libero per il cambio utensile.	Zone voor gereedschapswissel (*waarden bij max. gereedschap grootte): Houd dit gebied vrij voor de gereedschapswissel.	Зона замены инструмента (* расстояния приведены при использовании инструмента с максимальными размерами): для замены инструмента освободите эту зону.